

# Evaporative Emission Controls [KX, KS, KZ]



## Test

### COLD ENGINE

1. Check the vacuum line for proper connection, cracks, blockage or disconnected hose.

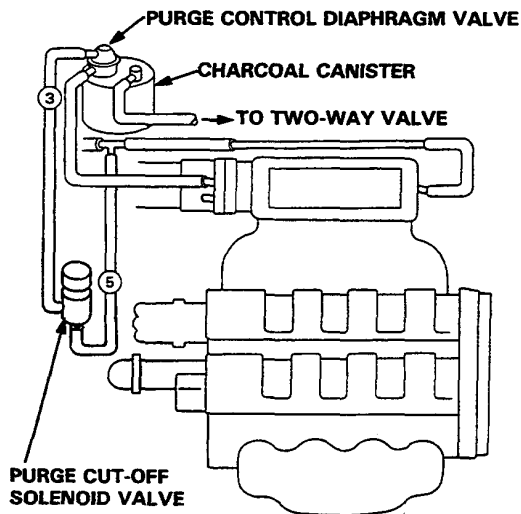

2. Disconnect #3 hose at the purge control diaphragm valve (on the charcoal canister) and connect a vacuum gauge to the hose.

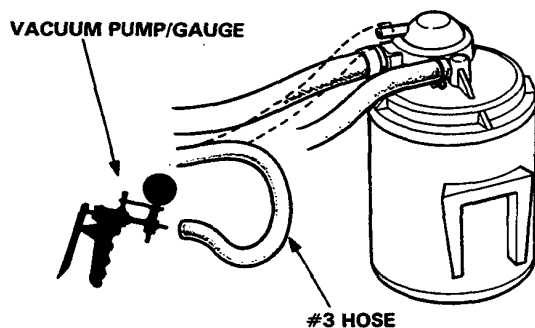

3. Start the engine and allow to idle.

NOTE: Engine coolant temperature must be below 70°C (158°F).

Vacuum should not be available.

- If there is vacuum, go to purge cut-off solenoid valve test II (page 6-215).

### HOT ENGINE

1. Disconnect the #3 hose at the purge control diaphragm valve (on the charcoal canister) and connect a vacuum gauge to the hose.
2. Warm up the engine to normal operating temperature (cooling fan comes on).

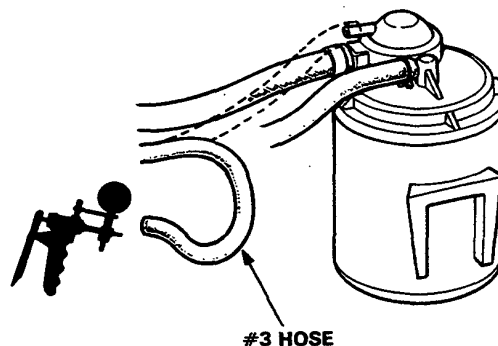

There should be vacuum at idle, once the engine is warm.

- If there is no vacuum, go to purge cut-off solenoid valve test I (page 6-215).

3. Disconnect vacuum gauge and reconnect the hose.
4. Remove fuel filler cap.
5. Remove canister purge air hose from frame and connect hose to vacuum gauge as shown.

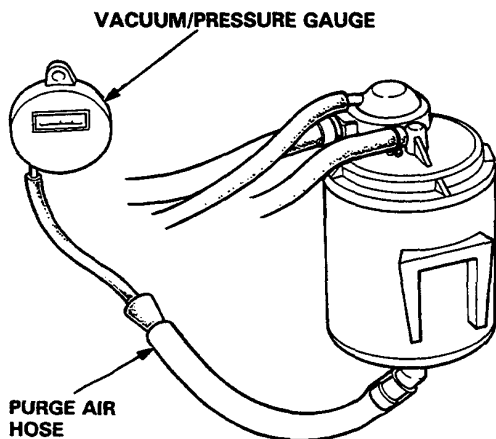

(cont'd)

# Evaporative Emission Controls [KX, KS, KZ]

## Test (cont'd)

6. Raise engine speed to 3,500 min<sup>-1</sup> (rpm)  
Vacuum should appear on gauge within 1 minute.
  - If vacuum appears on gauge in 1 minute, remove gauge, test is complete.
  - If no vacuum, disconnect vacuum gauge and re-install fuel filler cap.
7. Remove charcoal canister and check for signs of damage or defects.
  - If defective, replace canister.
8. Stop engine. Disconnect upper vacuum hose from canister "PCV" fitting.  
Connect a vacuum pump to canister "purge" fitting as shown, and apply vacuum.

Vacuum should remain steady.

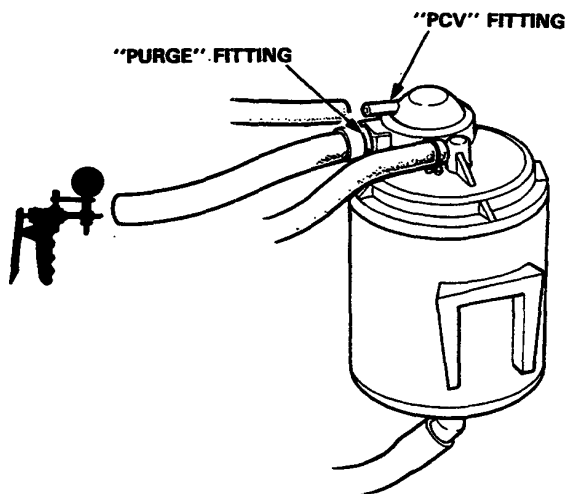

- If vacuum drops, replace canister and retest.
9. Restart engine. Reconnect hose to canister "PCV" fitting.  
"PURGE" side vacuum should drop to zero.
    - If "PURGE" side vacuum does not drop to zero, replace the canister and retest.

## Two-Way Valve

1. Remove the fuel filler cap.
2. Remove vapor line from the fuel tank and connect to T-fitting from vacuum gauge and vacuum pump as shown.

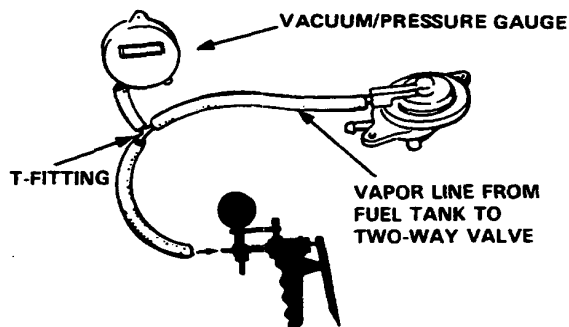

3. Slowly apply vacuum while watching the gauge.

Vacuum should stabilize momentarily at 5 to 15 mmHg (0.2 to 0.6 in. Hg).

- If vacuum stabilize (valve opens) below 5 mmHg (0.2 in. Hg) or above 15 mmHg (0.6 in. Hg), install new valve and retest.
4. Move vacuum pump hose from vacuum to pressure fitting, and move vacuum gauge hose from vacuum to pressure side as shown.

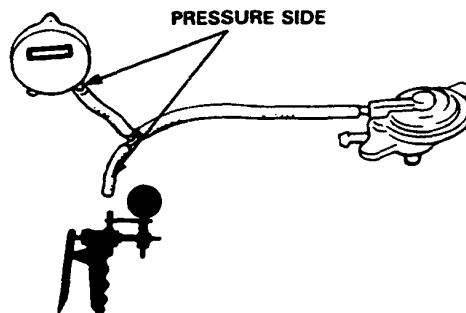

5. Slowly pressurize the vapor line while watching the gauge.

Pressure should stabilize at 10 to 35 mmHg (0.4 to 1.4 in. Hg).

- If pressure momentarily stabilizes (valve opens) at 10 to 35 mmHg (0.4 to 1.4 in. Hg), the valve is OK.
- If pressure stabilizes below 10 mmHg (0.4 in. Hg) or above 35 mmHg (1.4 in. Hg), install a new valve and retest.



## Solenoid Valve Test

### Test I:

1. Warm up the engine to normal operating temperature (cooling fan comes on).
2. Disconnect #5 hose from the vacuum hose manifold and connect a vacuum gauge to the hose.

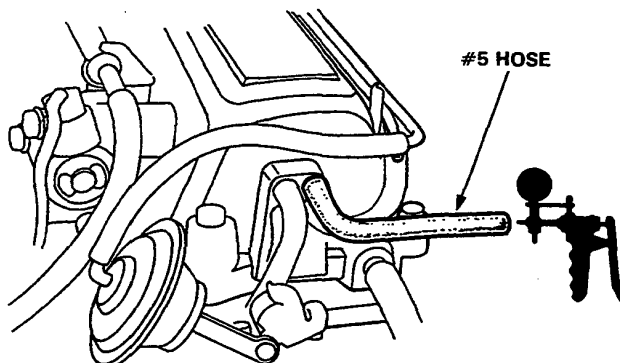

- If there is no vacuum, repair blockage at port or pinch in the #5 hose.

3. Disconnect the 2P connector from the purge cut-off solenoid valve and measure voltage between BLK/YEL (+) terminal and GRN/BLK (-) terminal.

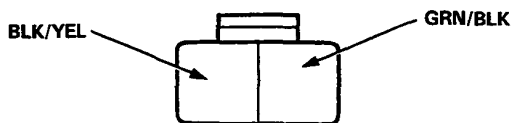

- If there is voltage, replace the purge cut-off solenoid valve and retest.
- If there is no voltage, measure voltage between BLK/YEL (+) terminal and body ground.
  - If there is no voltage, repair open in BLK/YEL wire between No. 12 fuse and the 2P connector.
  - If there is voltage, inspect open in GRN/BLK wire between the ECU (B2) and the 2P connector. If the wire is OK, substitute a known-good ECU and recheck. If symptom goes away, replace the original ECU.

### Test II:

NOTE: Engine coolant temperature must be below 70°C (158°F).

1. Start the engine and allow to idle.
2. Disconnect the 2P connector from the purge cut-off solenoid valve and measure voltage between BLK/YEL (+) terminal and GRN/BLK (-) terminal.



- If there is no voltage, replace the purge cut-off solenoid valve and retest.
- If there is voltage, inspect short in GRN/BLK wire between ECU (B2) and the 2P connector. If the wire is OK, substitute a known-good ECU and recheck. If symptom goes away, replace the original ECU.

# Evaporative Emission Controls [KQ, KY]

## Test

1. Check the vacuum line for proper connection, cracks, blockage or disconnected hose.

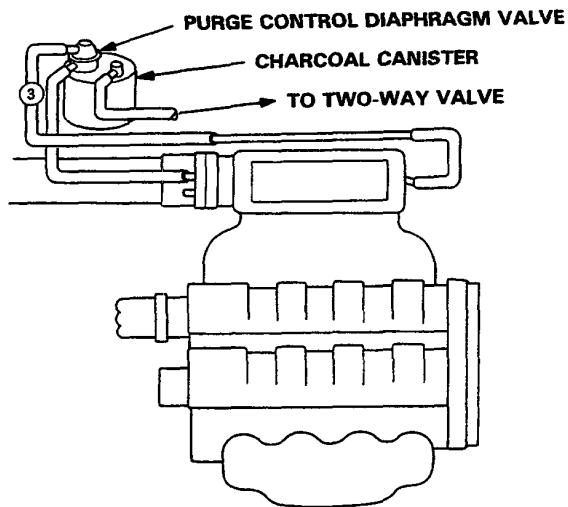

2. Remove fuel filler cap.
3. Remove canister purge air hose from frame and connect hose to vacuum gauge as shown.

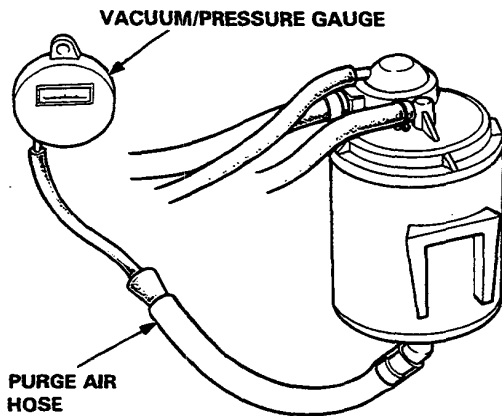

Raise engine speed to 3,500 min<sup>-1</sup> (rpm).  
Vacuum should appear on gauge within 1 minute.

- If vacuum appears on gauge in 1 minute, remove gauge, test is complete.
- If no vacuum, disconnect #3 hose from the purge control diaphragm valve and connect a vacuum gauge to the hose.

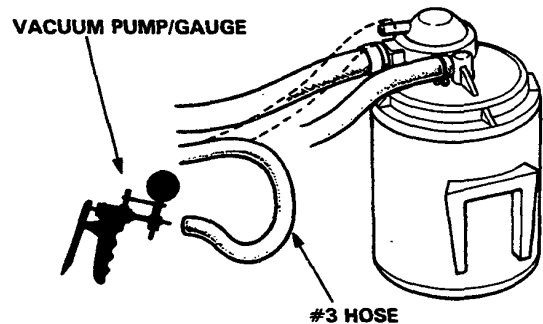

There should be vacuum at idle.

- If there is vacuum, replace the canister and retest.



## Two-Way Valve

1. Remove the fuel filler cap.
2. Remove vapor line from the fuel tank and connect to T-fitting from vacuum gauge and vacuum pump as shown.

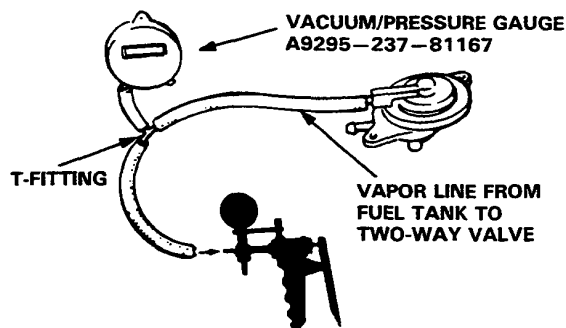

3. Slowly apply a vacuum while watching the gauge.

Vacuum should stabilize momentarily at 5 to 15 mmHg (0.2 to 0.6 in.Hg).

- If vacuum stabilize (valve opens) below 5 mmHg (0.2 in.Hg) or above 15 mmHg (0.6 in.Hg), install new valve and retest.

4. Move vacuum pump hose from vacuum to pressure fitting, and move vacuum gauge hose from vacuum to pressure side as shown.

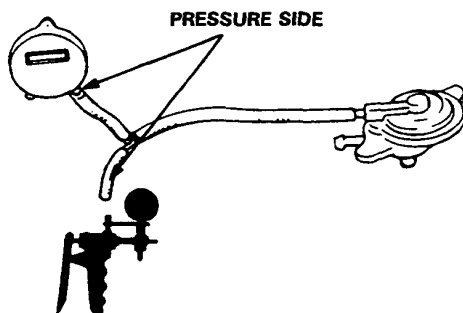

5. Slowly pressurize the vapor line while watching the gauge.

Pressure should stabilize at 10 to 35 mmHg (0.4 to 1.4 in.Hg).

- If pressure momentarily stabilizes (valve opens) at 10 to 35 mmHg (0.4 to 1.4 in.Hg), the valve is OK.
- If pressure stabilizes below 10 mmHg (0.4 in.Hg) or above 35 mmHg (1.4 in.Hg), install a new valve and retest.

## Test

1. Remove the fuel filler cap.
2. Remove vapor line from the fuel tank and connect to T-fitting from vacuum gauge and vacuum pump as shown.

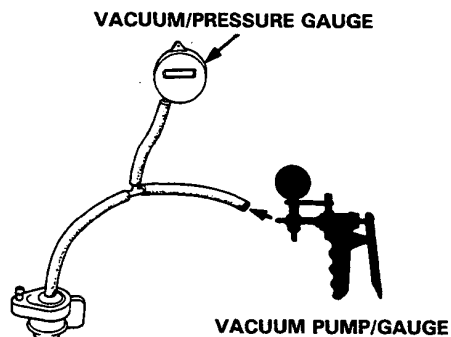

3. Slowly apply a vacuum while watching the gauge.

Vacuum should stabilize at 5 to 15 mmHg (0.2 to 0.6 in.Hg).

- If vacuum stabilizes (valve opens) out of above range, install new valve and re-test.

4. Move pump hose from vacuum to pressure fitting, and move vacuum gauge hose from vacuum to pressure side as shown.

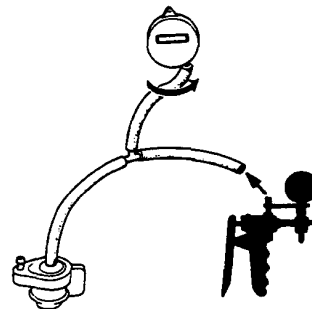

5. Slowly pressurize the vapor line while watching the gauge.

Pressure should stabilize momentarily at 10 to 25 mmHg (0.4 to 1.0 in.Hg).

- If pressure stabilizes momentarily (valve opens) at 10 to 25 mmHg (0.4 to 1.0 in.Hg), the valve is OK.
- If pressure stabilizes below 10 mmHg (0.4 in.Hg) or above 25 mmHg (1.0 in.Hg), install new valve and re-test.